

# BriPower ESA Series Programmable AC Power Supply

## Features

- Output power: up to more than 4MVA and above
- 4 quadrant operation, regenerative up to 100% of rated output power back to grid (-R option)
- Voltage and frequency sequencing programming via GUI, slew rate can be programmed
- Independent three-phase output
- Up to 50th harmonic waveform generation
- Soft start: effectively restrain the impulse current when power on
- Voltage drop simulation (LVRT test)
- High voltage ride through simulation
- Regenerative AC load function (-LD option)
- Line impedance (RL) simulation (-IMP option)
- Voltage and frequency sequencing programming via GUI, slew rate can be programmed
- ON/ OFF output phase angle can be programmed
- Current limit can be programmed, output can be shorted for short circuit test
- Trigger out, TTL signal output for voltage or frequency change
- Extend to DC output (-DC option)
- Adding single phase output (-1P option)
- Using water-cooling (-W option)
- Master-Slave interface (-MS option)
- Change to transformer output topology (-TR option)
- AC output frequency extended to 550Hz (only for CV mode) (-HF option)
- TFT-Touch panel operation
- LAN/RS485 interfaces (standard)
- RS232/Analog control interfaces (-ATI/-232 option)

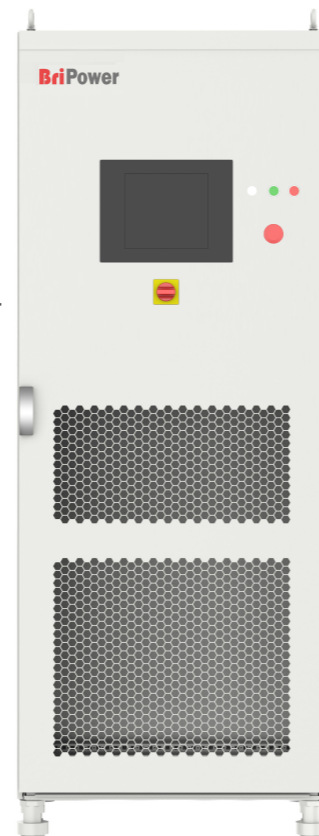

- Mod-bus/SCPI protocols
- Emergency stop button
- Remote sense
- CE conformity
- 13 months warranty

## Overview

The BriPower ESA series is a high-performance and multi-functional grid simulator, using advanced PWM technology, which contains multi output power levels from 45kVA to 240kVA for single system, and up to 4 individual systems can be paralleled to achieve power levels up to 960KVA and above. Output power level of customized system goes up to 4MW and above.

ESA series uses bi-directional design, which can be used as a grid simulator in varieties of applications such as in Smart Grid, Energy Storage, Solar etc. ESA can also be used as regenerative AC electronic load (- LD option)

ESA series adopts dual DSP+FPGA design, with powerful calculation and control capabilities, and can display and save measured values at 10k/s sampling. The ESA series adopts optical fiber communication and performs multiple monitoring and protection of all main components, communication connections and systems. It is a reliable power supply product.

With touch panel on the front panel, users can control the power source through GUI software. System status indicators and emergency stop button are installed on the front panel. RS485 and LAN standard interface, optional RS232 and analog control interfaces are available for automated test applications.

## Bi-Directional (Re-generative) –R option

With the -R option, the unit can operate in source and sink mode. It has the capability to return the energy fully back to the grid.

## Constant Power output

ESA series AC power supply has an automatic wide-range output function. Under the condition of rated output power, the output range of voltage/ current can be adjusted, such as: high-voltage small current or low-voltage large current (also applicable in sink power mode). The same type of power supply can cover a wider range of power applications.

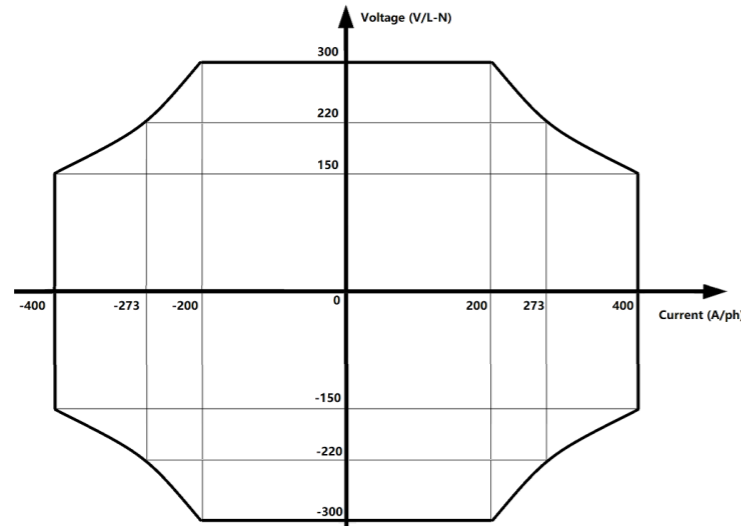

Example: 180kVA, 300V L-N, 400A/ph

## Re-generative AC Load -LD option<sup>1</sup>

ESA series with -LD option can be used as regenerative AC electronic load. This function consists of CR mode, Rectifier mode, CC/CP phase lead/lag mode. CR mode is used to simulate three-phase resistive loads, the CR mode and three-phase resistance parameters can be set through the panel and can realize the program of resistance sequence. Rectifier mode can be used to simulate non-linear loads, the CC/CP mode and CF (setting range: 1.414~3) parameters can be set through the panel. CC/CP phase lead/lag mode can simulate sinusoidal current, Constant current CC and constant power CP modes are available to adjust load current or power, phase angle can be set from 90° to -90° simulating the voltage and current conditions under inductive and capacitive loads.

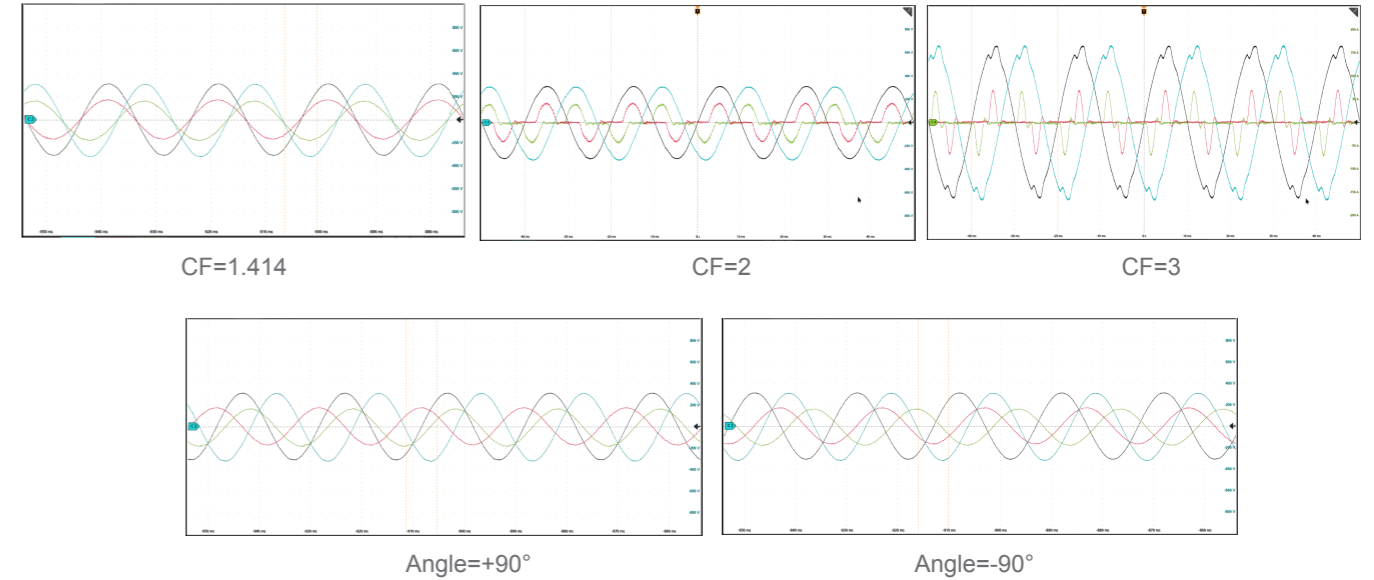

<sup>1</sup>ESA-LD is suitable for the case where the input voltage is a pure sine wave. If the input voltage is not a pure sine wave, the output current waveform may be affected. The -LD option must be used in combination with the -R option.

## Grid Simulation

ESA series can be used as a grid simulator to meet the requirements of grid tied DG regulations testing, such as: grid voltage abnormality test, grid frequency abnormality test, high voltage ride through test, low/zero voltage ride through test, anti-islanding test, etc.

ESA series has various simulation functions, including: voltage and frequency fluctuations, voltage sags, high voltage ride through, low/zero voltage ride through, three-phase unbalance, harmonics and inter-harmonics. ESA series provides standard software that can simulate various real-world power grid operating conditions and supports multiple parameter settings.

## Voltage/frequency sequence programming

Voltage and frequency sequence programming via GUI, and the output voltage, frequency, slew rate,

ON/ OFF output phase angle, dwell time, switching time can be programmed. Three-phase can be independently programmed.

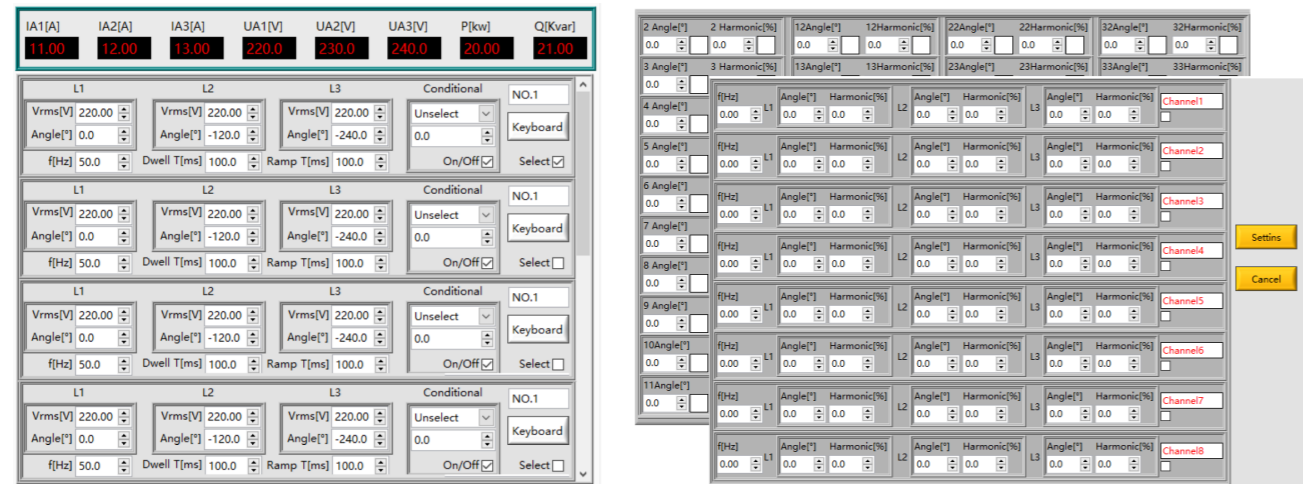

Sequence programming

Harmonic/Inter-harmonic editing

## Harmonic and inter-harmonic waveforms

DSP+FPGA technology are use in ESA series to generate up to 50th harmonic. And ESA series supports inter-harmonics editing. Users can program the phase angle and amplitude of the harmonic through the GUI, allowing generate three-phase harmonic/inter-harmonic waveforms independently.

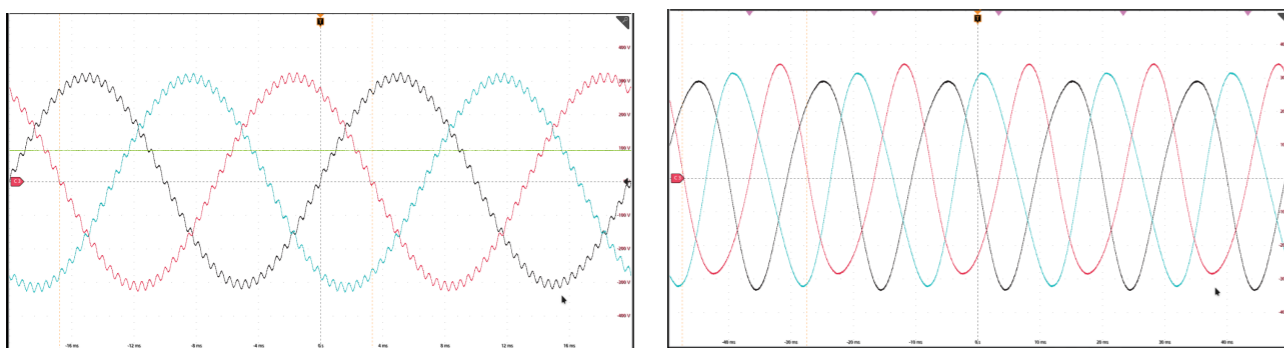

Harmonic waveform

Inter-harmonic waveform

## Voltage drop simulation (LVRT test)

ESA series provides firmware and software support for low/zero voltage ride through tests.

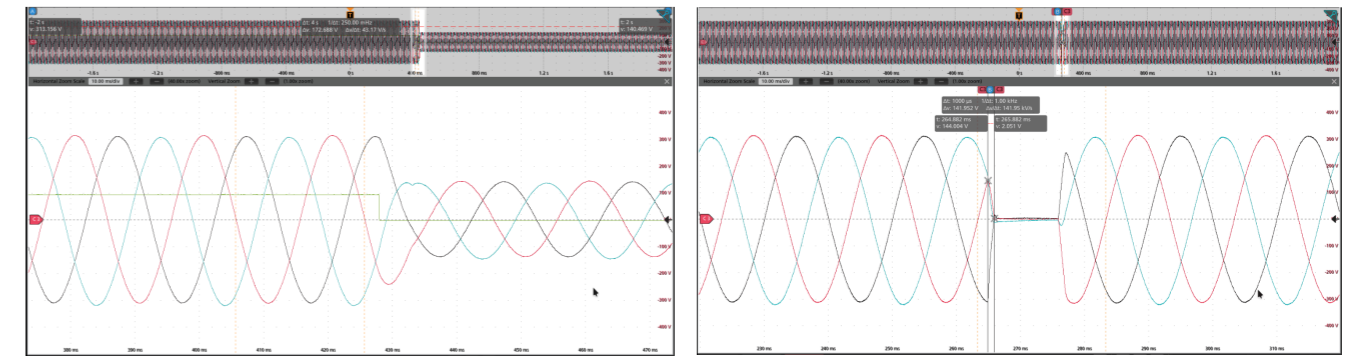

Voltage drop

Zero voltage ride

## Power supply + Electronic RLC load for anti-islanding test –62116 option

The -62116 option of ESA series provides a perfect solution for anti-islanding test. ESA with -62116 options acts as power supply + electronic RLC load in this application. During the anti-island test, ESA-62116 simulates RLC load<sup>2</sup>, and meets test requirement of IEC62116-2008.

In the test procedure of IEC62116-2008, there is no need to set R, L, C directly, all related settings are to set QL, PAC, QAC by adjusting R, L, C value. In ESA-62116 solution, user can set these parameters directly, and equivalent R, L, C values will be displayed.

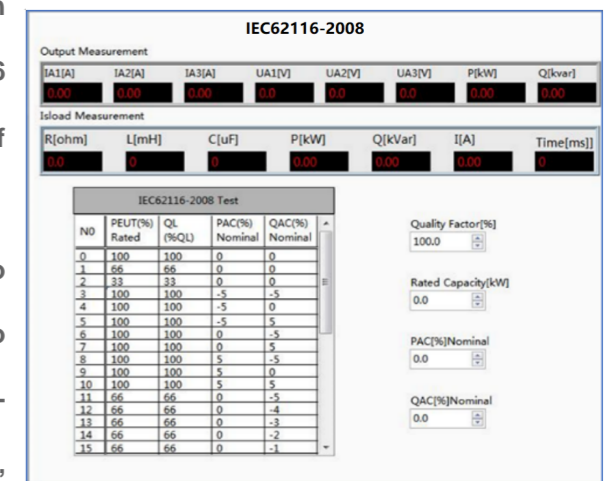

IEC62116-2008 Test

<sup>2</sup>ESA-62116 can only simulate RLC load for sine waveform, 50/60Hz input.

## Line impedance (RL) Simulation –IMP option

ESA series with -IMP option can simulate output line impedance (RL). The impedance range is up to Rated V/Rated I; and can be set in percentage in GUI software.

## Extends to DC output –DC option

DC output mode is available with the -DC option. The output will be DC and AC 0~100Hz, in both source and sink mode. There is up to 50% output power and current derating below 30Hz. The DC voltage range is 420V(std), and accuracy is 0.2%FS. The output mode can be AC, DC or AC+DC.

## Change to transformer output topology (-TR option)

With -TR option, a three-phase independent transformer will be used at the output end, and the frequency output range is 40-70Hz, which meets most of the power frequency test requirements. (ESA doesn't use transformer at output by default).

## Graphical User Interface

GUI software is installed in front touch panel, which uses Windows OS. The software provides following functions:

- Output settings and limits
- Sequence output settings
- Generate harmonic and inter-harmonic waveforms
- Display measurements: voltage, current, power, etc.
- Capture, display and save output voltage and current waveforms
- Display power source faults

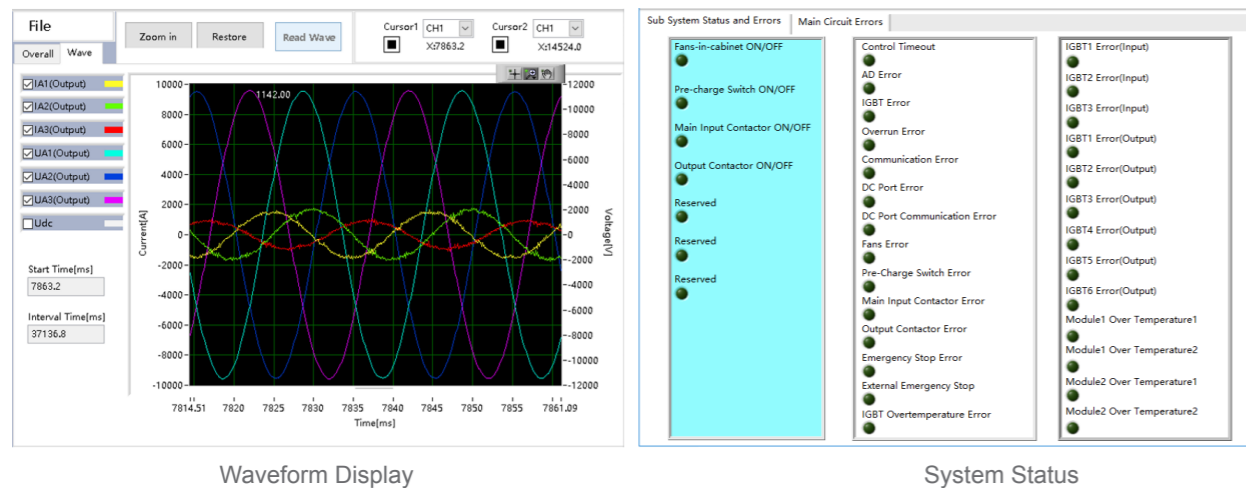

## Block Diagram

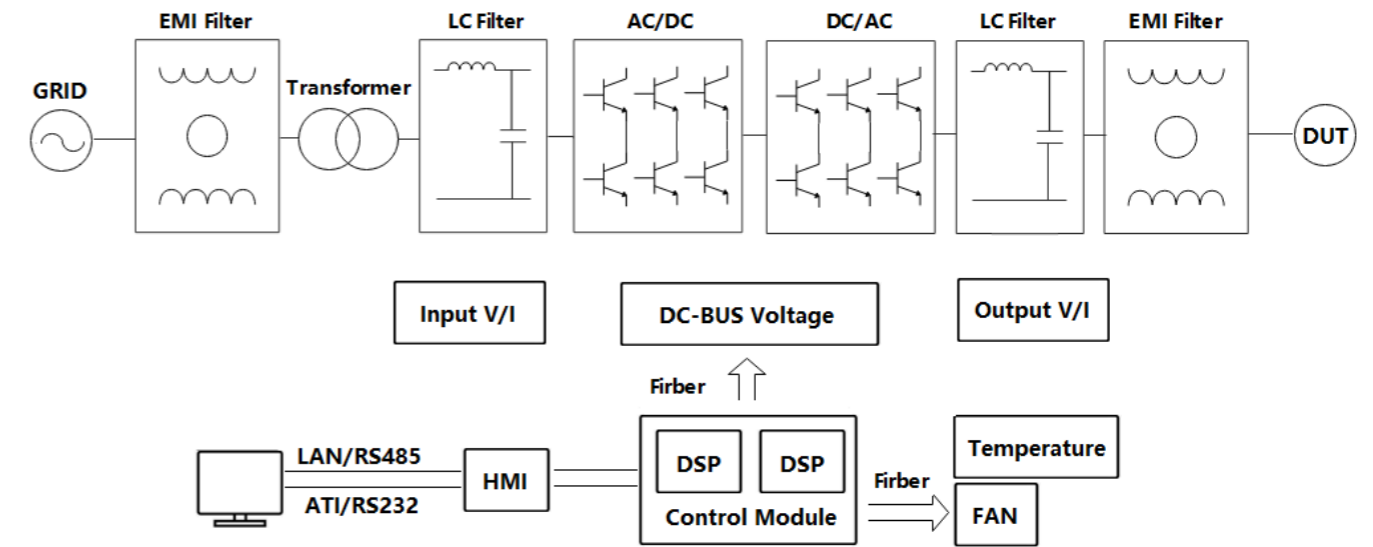

One 3-phase transformer is used on the input. The 3-phase AC input is rectified by four quadrant PWM converters, and in this topology, DC bus is generated, which provides power to the DC/AC power modules. Three DC/AC power modules are used, which corresponds to 3 phases AC output.

Note: The ESA series AC power supply topology with -TR option is different from the above figure.

## General Specification

(customized unit specification will be shown in the proposal)

Input	
AC input Voltage	3P+N+PE, 380VLL±10%(std)
Frequency	47-63Hz
Efficiency	≥90%
Power Factor	0.95
THDi	≤3%

<b>Output</b>	
Output Modes	AC
Power Level	Single system 30-240KVA, customized up to 4MW and above
Voltage Ranges	0-300V L-N (std), voltage can be customized.
Current Ranges	Please refer to the Standard Models Specification
Frequency range	Standard 30-100Hz
Phase output	Phase B/C relative to phase A, 0.0~360.0°
Voltage Rise Time (10%~90%)	<1ms
Voltage Fall Time (90%~10%)	<1ms
Harmonic Generation	Up to 50th
Load Regulation	0.2%FS
Line Regulation	0.1%FS
Output Voltage THD	<1%FS (Resistive Load, @50/60Hz)
Power Accuracy	0.3%FS
Voltage Accuracy	0.1%FS
Current Accuracy	0.2%FS
Frequency Accuracy	0.01Hz
Phase accuracy	±0.3° @50Hz
Power Resolution	0.1kW
Voltage Resolution	0.01V
Current Resolution	0.1A
Frequency Resolution	0.01Hz
Phase Resolution	0.1°
<b>Measurements</b>	
Power Accuracy	0.3%FS

Voltage Accuracy	0.1%FS
Current Accuracy	0.2%FS
Frequency Accuracy	0.01Hz
Phase accuracy	±0.3° @50Hz
<b>Others</b>	
Standard Interface	LAN/RS485
Optional Interface	ATI/RS232
Protection	OVP, OCP, OPP, OTP
CE Conformity	EN 62040-1, EN 62040-2
Cooling	Forced Air Cooling
Temperature	Operating: 0~40°C Storage: -20~85°C
Operating Humidity	20-90%RH (None Condensing)

## Standard Models Specification

Model	Power	Voltage	Current	Dimension(W*D*H mm)	Weight(kg)
ESA 45-300-68-R	45kVA	300VL-N	68A/ph	800*800*2000	720
ESA 60-300-91-R	60kVA		91A/ph	800*800*2100	750
ESA 120-300-181-R	120kVA		181A/ph	1800*900*2200	1300
ESA 150-300-227-R	150kVA		227A/ph	1800*900*2200	1600
ESA 180-300-273-R	180kVA		273A/ph	1800*900*2200	1600
ESA 250-300-378-R	250kVA		378A/ph	1800*900*2200	2000
ESA 300-300-454-R	300kVA		454A/ph	2700*900*2200	2800
ESA 500-300-757-R	500kVA		757A/ph	5400*900*1900	4600

**Note:**Total weight < 1400KG, the cabinet bottom is wheel structure; otherwise, it is channel steel structure.

## Options

-232	RS232 program interface
-LD	Regenerative AC load function
-R	Regenerative mode
-ATI	Analog control interface (0~5V)
-DC	Extend output frequency to DC
-1P	Add single phase output
-IMP	Line impedance (RL) simulation
-MS	Master-Slave interface
-W	Use water-cooling
-TR	Change to transformer output topology
-HVXXX <sup>3</sup>	Extend output voltage range to 400V, 530V or 700 V (L-N)
-CFG <sup>4</sup>	Configurable Power/Voltage/Current range
-62116	Power supply + Electronic RLC load for anti-islanding test
-HF <sup>5</sup>	AC output frequency extended to 550Hz (only for CV mode)

<sup>3</sup> For -HVXXX option, the model number will be ESA AAA-HVXXX-CCC-DDD (AAA: power, XXX: voltage, CCC: current, DDD: other option). There is only one voltage range, for example, ESA 250-HV530-378, the output voltage range is 0~530V L-N.

The current range is not decreased with -HVXXX option, which means, for example ESA 250-HV530-378 has the same current range as standard model ESA 250-300-378. The ESA units can output full power at 220V L-N.

<sup>4</sup> Customized power/voltage/current range is possible with -CFG option. Please consult factory.

<sup>5</sup> Max VF Derating 300V L-N Range

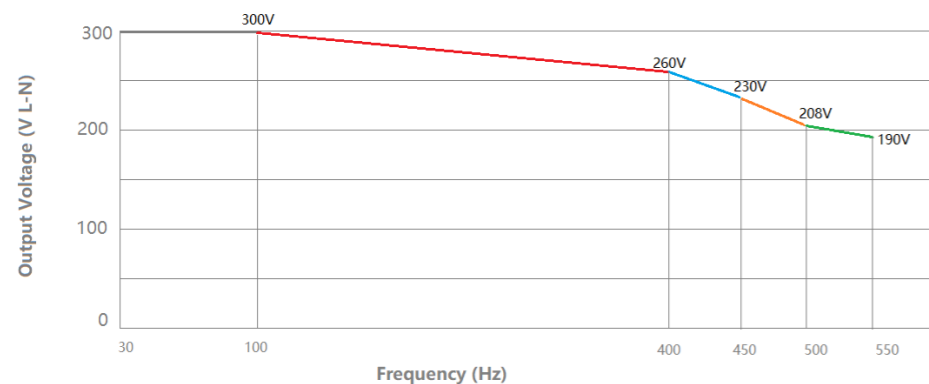

## AC Input Configuration <sup>6</sup>

Please specify the input voltage (L-L)

/380, Input Voltage 380V±10%, 3-phase

/400, Input Voltage 400V±10%, 3-phase

/480, Input Voltage 480V±10%, 3-phase

## Model Configuration

ESA AAA-BBB-CCC-DDD/EEE

AAA: Power, kVA

BBB: Voltage (L-N), V (std, 300V L-N)

CCC: Current (per Phase), A

DDD: Option

EEE: Input configuration

<sup>6</sup> other AC input is available, please consult factory.



## About BriPower

Bridge Technology is a company focusing on business of **power supplies and test systems for new energy applications**. We are devoted to providing high quality products and solutions for customers.

Bridge Technology has **a top-class R&D team** in China, works on modularization and standardization power supplies and systems. We have sales, technical support, R&D and manufacture in Shanghai, Nanjing and Chengdu.

**Nanjing Bridge New Energy Technology** was founded on Jan 12th, 2016, focusing on R&D and manufacturing BriPower brand power systems, including bi-directional AC sources for grid simulation, bi-directional DC sources for battery simulation, and regenerative loads. The BriPower AC&DC power systems are widely used in new energy and related fields.

Factory: Nanjing Bridge New Energy Technology Co., Ltd

Sales Company: Shanghai Bridge Electronic Technology Co., Ltd

General information: [info@bridgetech.cn](mailto:info@bridgetech.cn)

Technical Support: [support@bridgetech.cn](mailto:support@bridgetech.cn)

Repair & Calibration: [service@bridgetech.cn](mailto:service@bridgetech.cn)

Tel: 40010-18618

Int'l Sales: [contact@bridgetech.com.sg](mailto:contact@bridgetech.com.sg)